

Housing/frame: in die-cast aluminium with wide cooling fins for heat dissipation.

Base: in vandal resistant fibreglass nylon.

Diffuser: silk-screen printed, tempered.

Coating: in several stages. First stage: epoxy cationic electrocoating, resistant to corrosive and saline environments. Second stage: UV-stabilising primer, and final stage rough finish with metallic silver acrylic coating.

Electric gear: 12V power supply.

Equipment: cable gland, Ø 1/2 gas thread.

1536 Koala				
		CTL		Lamps (Ta=25°C)
wattage	colour	weight	code	Kelvin - ølm - Ra
ALO-IRC 50	m. silver	2.00	431810-00	3000K - 1250lm - Ra 1a
DICR 50	m. silver	2.00	431811-00	3000K - 1500cd - 38° - Ra 1a
AR 70/50	m. silver	2.00	431812-00	3000K - 12500cd - 8° - Ra 1a

Supplied with lamp and toroidal transformer. **Lamps ALO-IRC:** power saving lamps provide a luminous efficiency 33%. Duration (4000 hours) and better performance.
50W = 35W IRC - 75W = 50W IRC

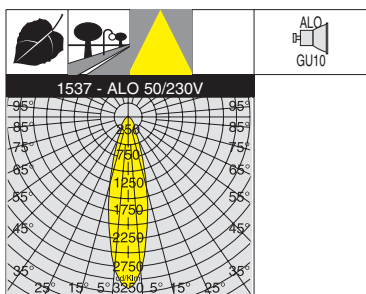

Electric gear: 230V power supply.

1537 Koala - 230 V				
		S+L		Lamps
wattage	colour	weight	code	
ALO 50	m. silver	1.50	431815-00	24°

Supplied with 230V lamp; mains voltage operated without transformer.

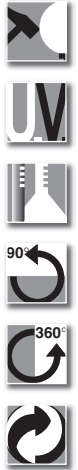
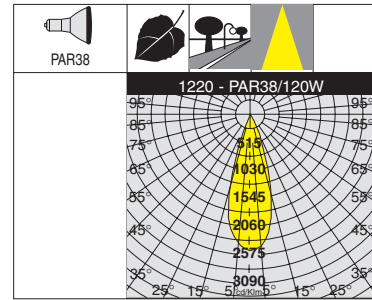
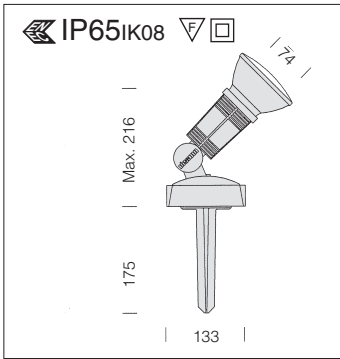

Housing/frame: in fibreglass and self-extinguishing nylon.

Equipment: Supplied with base and ground-sinking spike. Standard supply includes 2 cable glands.

Accessories: possibility of installation on acc. 116/118/120/121.

1220 Dafne				
		S		Lamps
wattage	colour	weight	code	
PAR 38	black	0.30	431801-00	Use PAR 38 lamp of 80W or 120W lamp only.
Supplied with 230V lamp; mains voltage operated without transformer.				

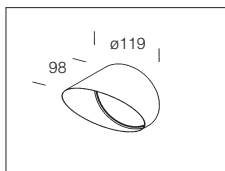

acc. 114 conveyor	
m. silver	991330-00
In aluminium. To direct the light beam in one direction. Only for art. Koala.	

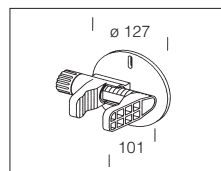

acc. 118 clamp	
black	991334-00
In fiber glass nylon. Enables Koala/Dafne to be installed on different surfaces without the need to fix it definitively. Clamp opening between 20mm (min) and 60mm (max).	

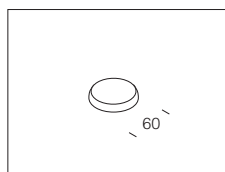

acc. 115 pole cap	
black	991331-00
In fiber glass nylon. To apply to Ø60 mm pole (acc. 5). End cap for the pole top.	

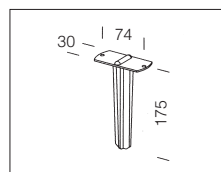

acc. 119 spike	
black	991335-00
In fiber glass nylon. For planting Dafne into the ground.	

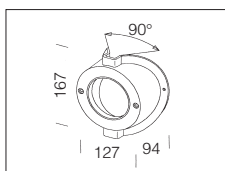

acc. 116 corner support	
black	991332-00
In fibreglass nylon. To install Koala/Dafne on a corner.	

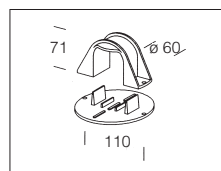

acc. 120 pole support	
black	991336-00
In fibreglass nylon. To apply Koala/Dafne on any Ø 60 pole in any position.	

