

Fluted pole made of extruded aluminium, anodised by 15/20 $\mu$  thick tin salt electrocoating; black, graphite or natural oxidised colour.

With die-cast inspection window (186x45mm), protective fuse holder, 10A fuse, 4-pole/3-way removable terminal block = 6 sqmm, 4 sqmm connection. With hole for insertion of power supply cable. Die-cast aluminium adapter,  $\varnothing$ 60 mm. For the version with base, 4 log bolts to be sunk into the ground, bolts and lids have to be purchased. Standard insulation class II. When using Insulation Class I fixtures, appropriate grounding connections should be included in the system.

NOTE: The possibility to attach an assembly to the pole is subject to a wind pressure resistance assessment in the areas regulated by CNR-UNI standard 10032-67, according to load assumptions in UNI UNI 40/6 standard. An accurate and suitable protection or insulation of the surfaces involved is recommended to avoid any direct contact with the new masonry or concrete screed.

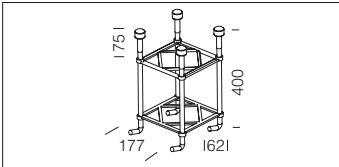

#### acc. 299 log bolts

991396-00

Log bolts are to be always bought with the pole 1408.

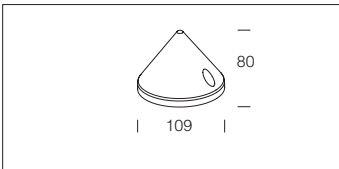

#### acc. 367 cover for poles

ox. black 426995-00

ox. nat. 426998-00

graphite 426997-00

Made of aluminium. To be used when a particular aesthetic finish is desired.

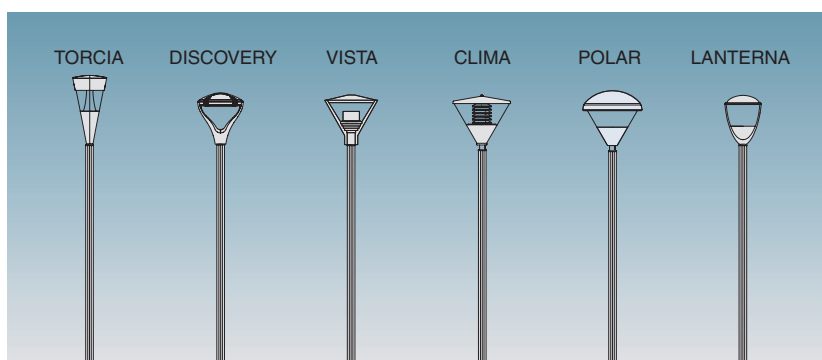
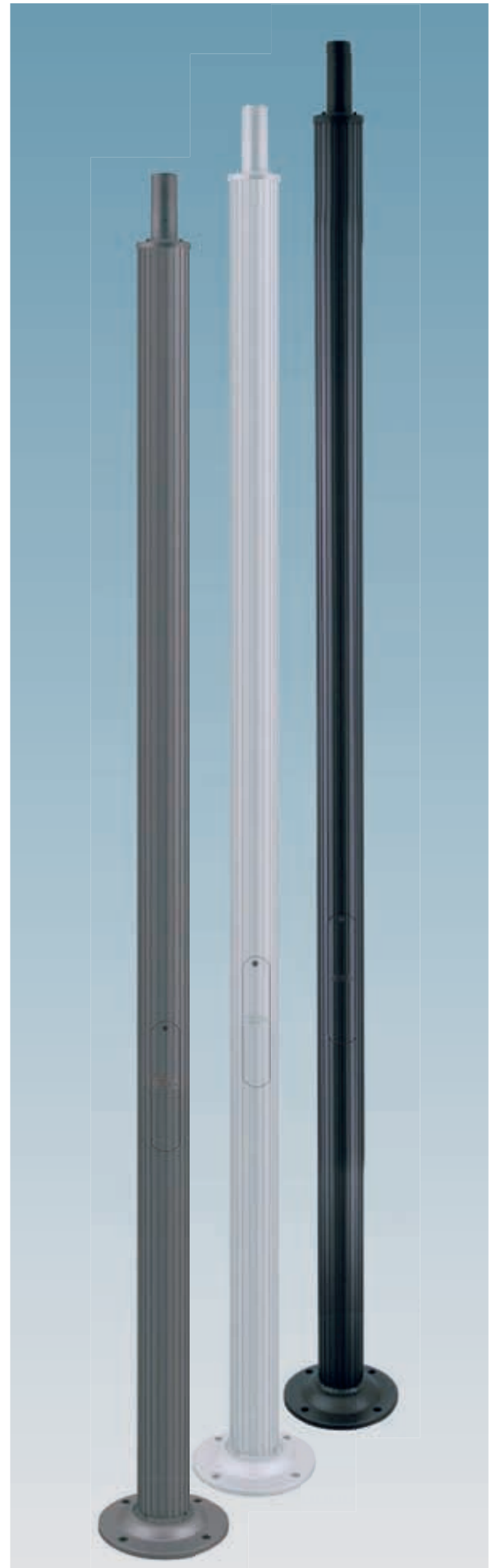

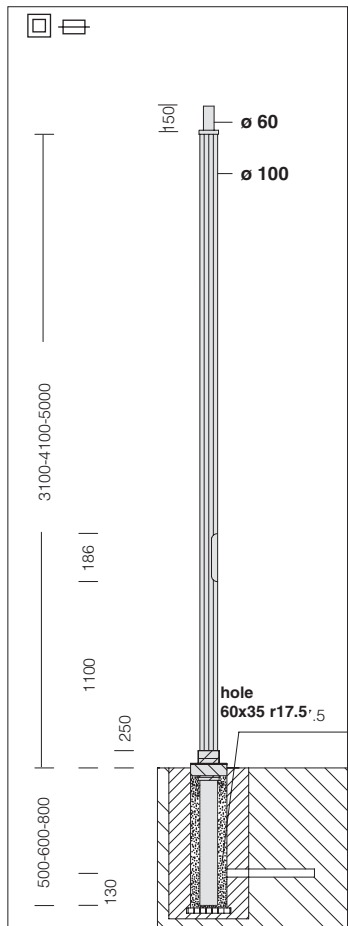

Inspection window with easily removable terminal block for quick connection.

The size of the plinth depends on the type of pole, the composition used, the type of terrain on which the plinth stands, and the material of which it is made.



**acc. 1409 fluted pole Ø 100**

colour	code								
oxy black	426340-00	3600	3100	500	1100	186	45	Ø 100	Ø 60
oxy black	426341-00	4700	4100	600					
oxy black	426342-00	5800	5000	800					
oxy natural	426334-00	3600	3100	500					
oxy natural	426335-00	4700	4100	600					
oxy natural	426336-00	5800	5000	800					
graphite	426327-00	3600	3100	500					
graphite	426328-00	4700	4100	600					
graphite	426329-00	5800	5000	800					

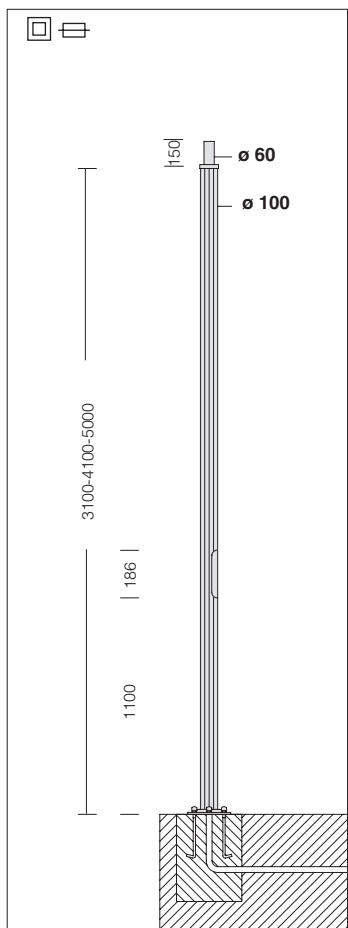

Inspection window with easily removable terminal block for quick connection.

For correct installation of pole and base, the ceiling cap should be fitted as shown in the assembly drawing featured opposite.

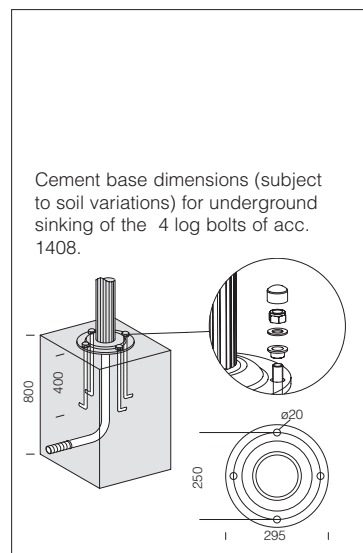

**acc. 1408 fluted pole with base Ø 100**

colour	code								
oxy black	426345-00	3100	1100	186	45	Ø 100	Ø 60	Ø 295	hole Ø 20
oxy black	426346-00	4100							
oxy black	426347-00	5000							
oxy natural	426337-00	3100							
oxy natural	426338-00	4100							
oxy natural	426339-00	5000							
graphite	426324-00	3100							
graphite	426325-00	4100							
graphite	426326-00	5000							

**Log bolts are to be bought separately acc. 299.**

